

PFAFF® *creative icon*™ 2 Quilt Pillow Instructions



The PFAFF® *creative icon*™ 2 sewing and embroidery machine is the perfect tool to release your creativity. Create a fun and unique pillow inspired by the *creative icon*™ 2 quilt featuring an exclusive stitch technique, echo quilting and a free pattern.

Materials

- Freezer paper 24x24" (60x60cm)
- Pen or pencil
- Fabric marking tool
- See color chart for fabric requirements
- Fusible batting 24x24" (60x60cm)
- Tear-away or wash-away stabilizer
- 1 zipper 22" (56 cm)
- Matching sewing thread
- Metallic thread for decorative floating stitches
- Matching embroidery threads for decorative quilting
- Scrap fabric for the backside of the quilt top 24x24" (60x60cm) (will not show on the finished item)

Preparing the Pattern

- Using your pen or pencil, copy the pattern to the dull side of the freezer paper. Be sure to copy all markings and text as well.
- Cut out the pattern pieces and sort them in color order.
- Fuse the freezer paper pattern pieces to the front of the fabric pieces and cut them out after adding 1/4 " (6mm) seam allowance around the fused shape. Copy all the piecing marks to the edge of the fabric, using a fabric marking tool.
- Lay the fabric pieces on top of the original pattern but do not remove the freezer paper yet – it is much better to do that just before the pieces are sewn together.

Piecing the Top

It is important to match the piecing marks from the pattern to align the pieces properly. After you have sewn the different sections, put them back in the right place on top of the original pattern.

Tip: Use the 1/4" inch foot for the best result.

1. Sew A,B,C and D together.

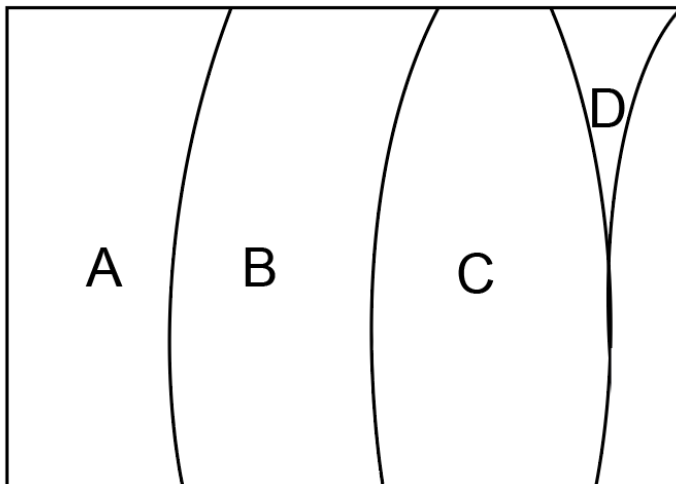

2. Sew E, F, G and J together.

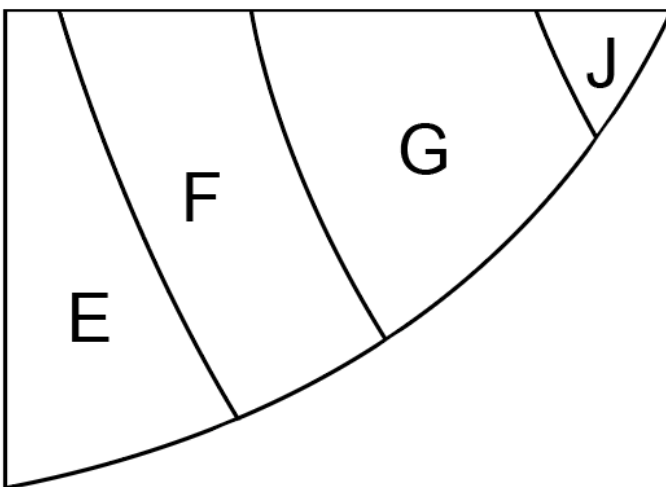

3. Sew H and K together.

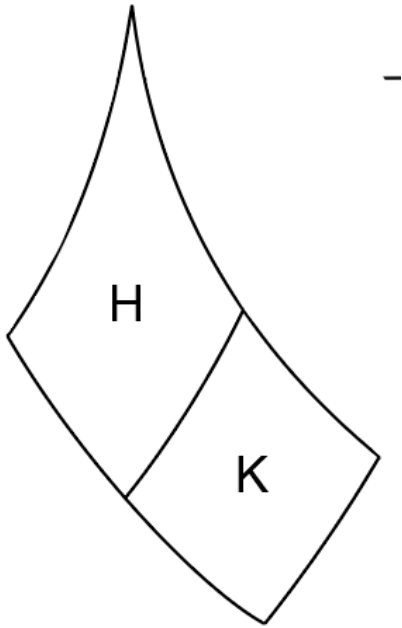

4. Sew L, M and N together.

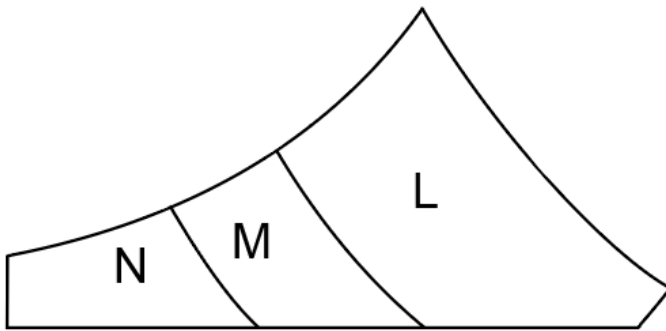

5. Sew P and Q together.

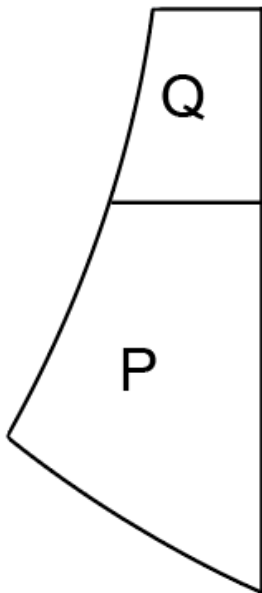

6. Sew S and R together.

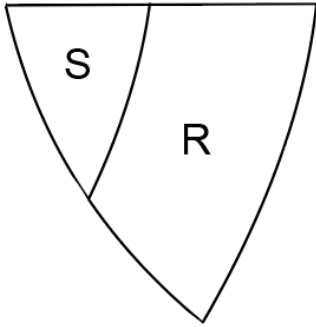

7. Sew T, U and V together.

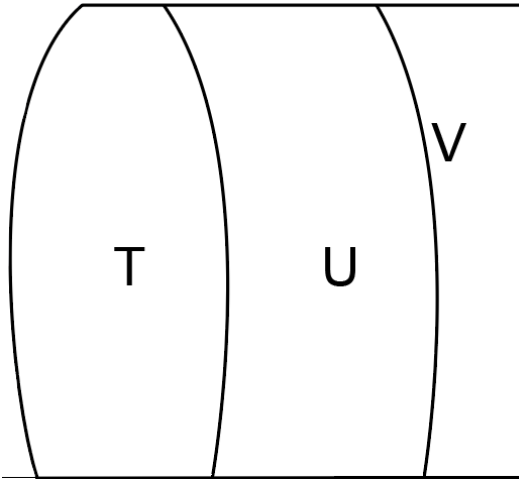

8. Rethread the machine with metallic thread.

9. With your ABCD and I pieces right sides together, place a piece of stabilizer behind where you will stitch and sew using a floating stitch from menu 8.5.

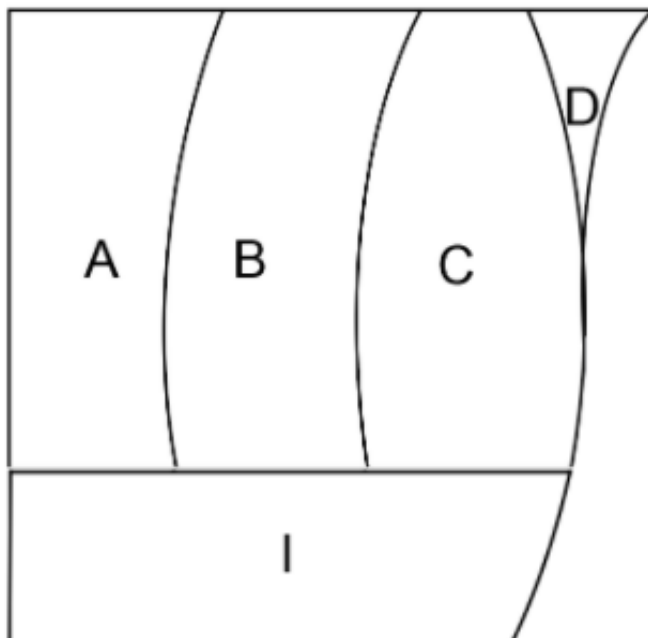

10. Pull the seam apart from the right side to reveal your stitch.

11. Repeat with EFGJ and I. This piece will now be referred to as piece 1.

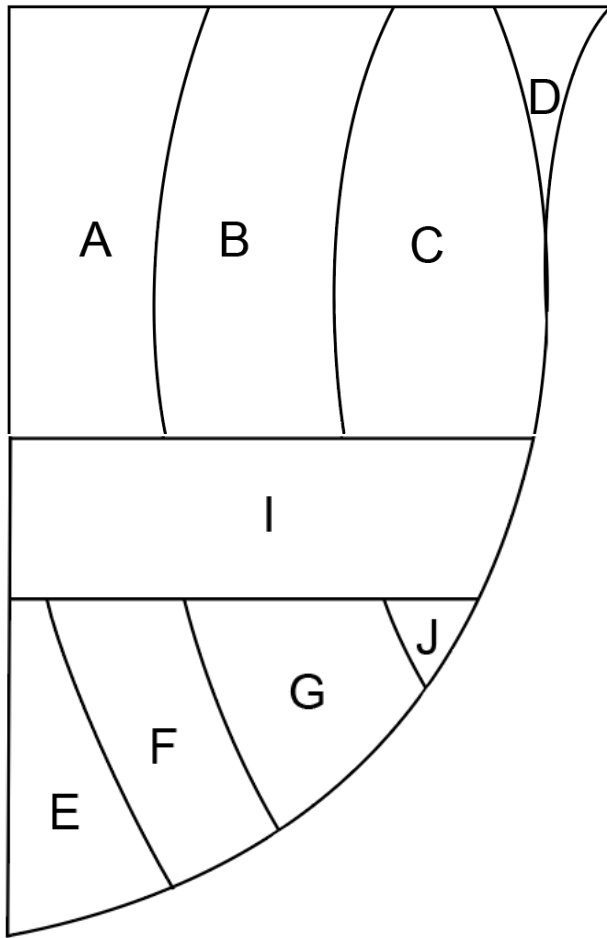

12. Repeat with Q and P.

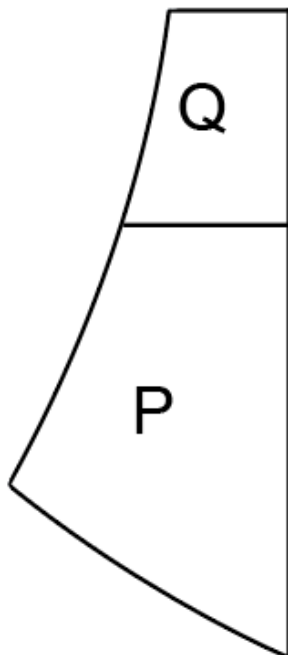

13. With the match thread, sew PQ and RS together with the normal 1/4" seam allowance on a straight stitch.

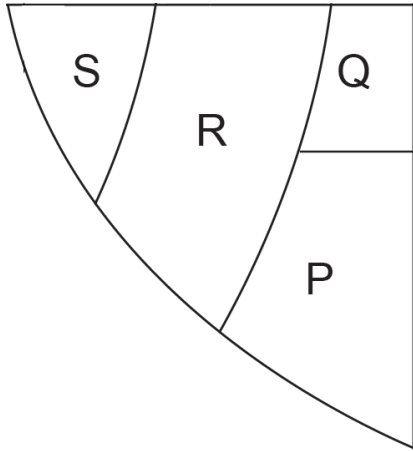

14. Switching back to metallic thread, place stabilizer behind your stitching area and sew together TUV and PQRS with a floating stitch from menu 8.5. This piece will now be referred to as piece 2.

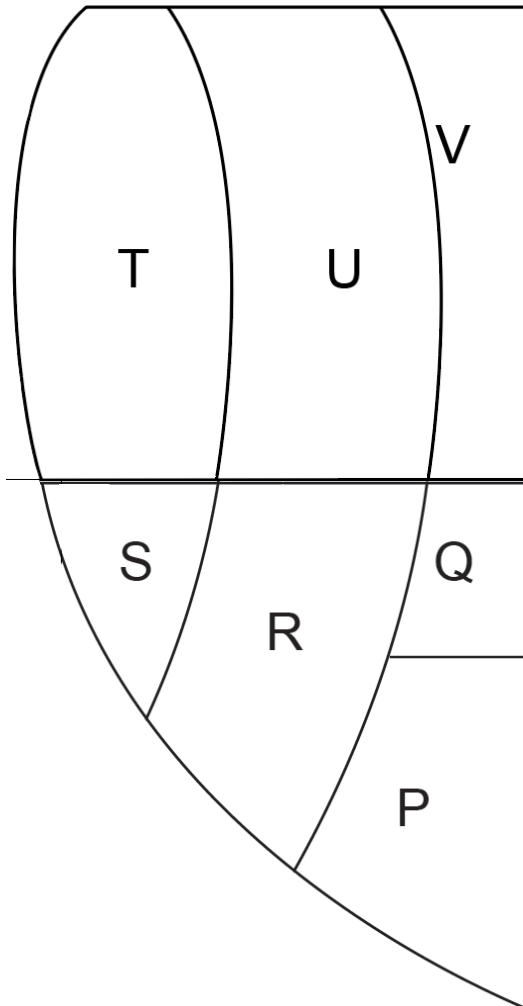

15. Switching back to matching thread, sew HK and LMN together and then sew O on the end. This piece will now be referred to as piece 3.

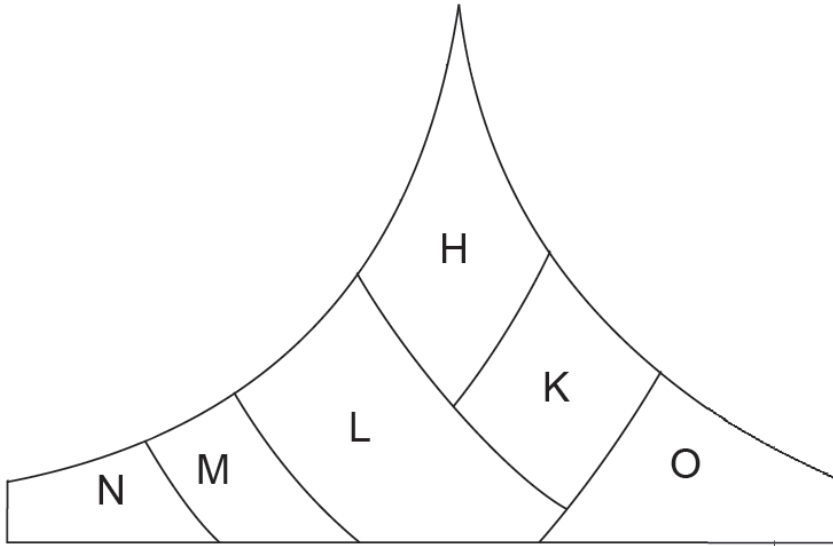

16. Sew piece 1 and piece 3 together.

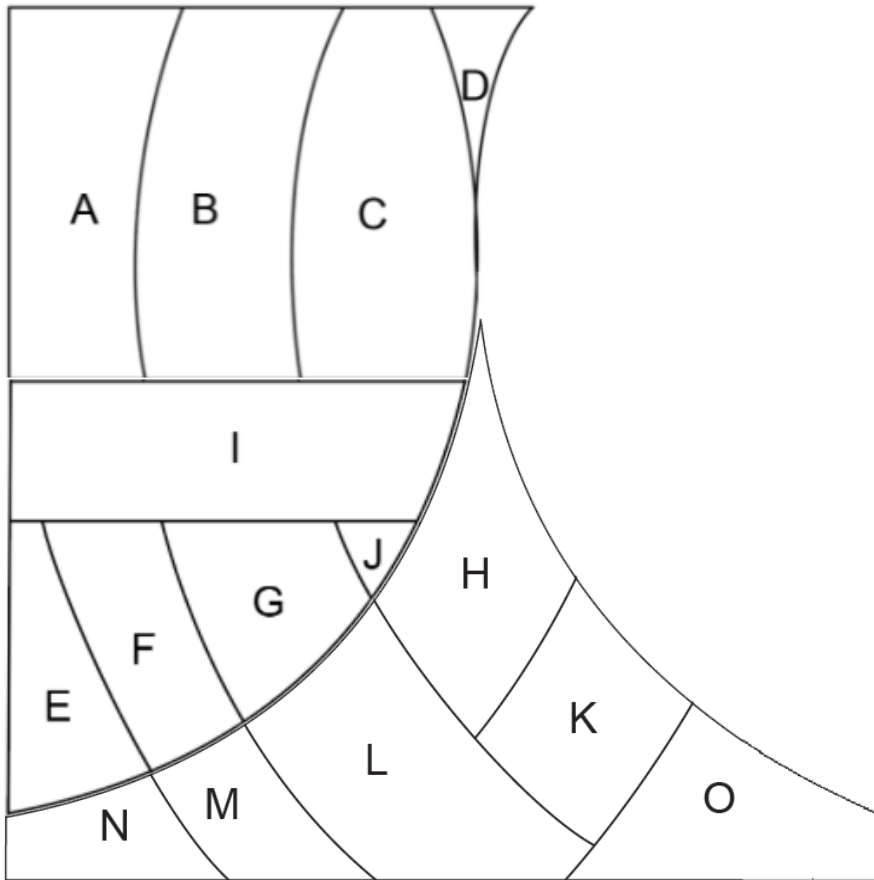

17. Then add piece 2.

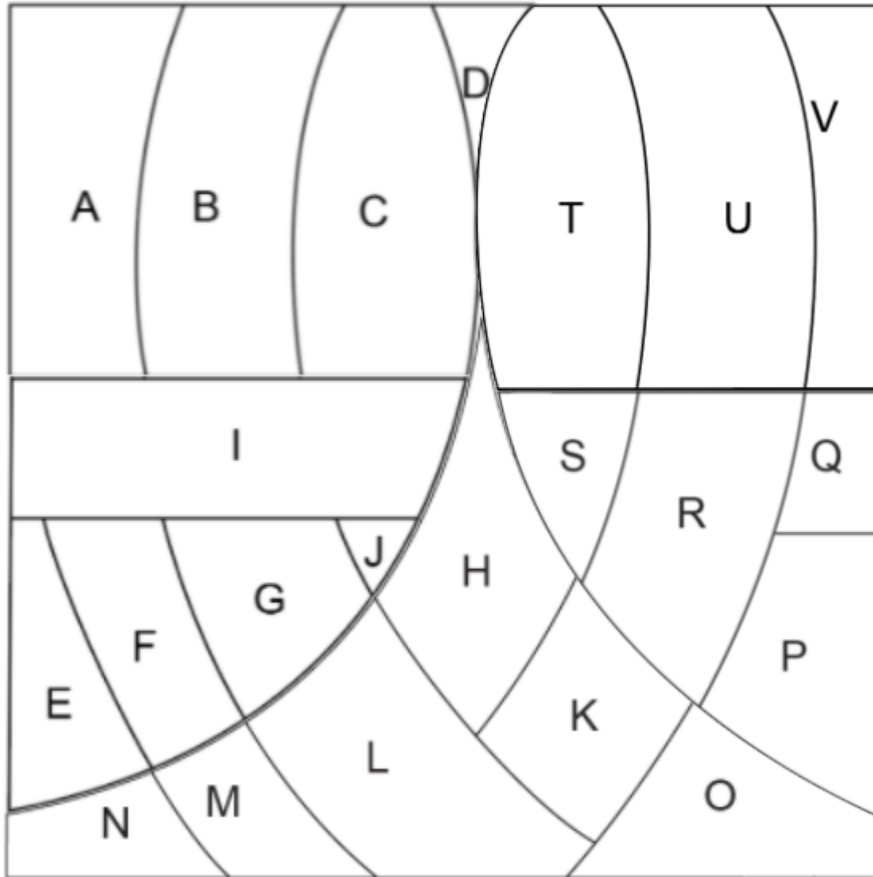

18. Press the quilt and square it up to approx. 17x17" (42x42cm).

Add Borders

- Cut four strips 3"x24" (8x61cm) from pillow fabric.
- Sew them onto the sides of the quilt top.
- Press the seam allowance towards the border.

Quilting

- Press the fusible batting onto the pillow front
- Put scrap fabric under the quilt sandwich. This will make the quilting more visible.
- Quilt in the ditch around the pattern pieces and add some echo quilting inside the shapes. Use invisible thread for texture or embroidery thread for more of a statement.
- When finished quilting, trim the quilt square leaving about 2" (5cm) of the border all around.

Finishing

- Use the remaining fabric to make the back of the pillow.
- Add a zipper in the back for easy removal.
Tip: check out the zipper tutorials in the Help Center for more information.
- Enjoy your unique new creation!



Color One 8"x12" (20x30cm)	Color Two 7"x10" (18x25cm)	Color Three 8"x10" (20x25cm)
		
Color Four 6"x8" (15x20cm)	Color Five 8"x12" (20x30cm)	Color Six 4"x5" (10x13cm)
		
Color Seven 4"x12" (10x30cm)	Color Eight 4"x7" (10x18cm)	Color Nine 5"x7" (13x18cm)
		
Color Ten 5"x9" (13x22cm)	Color Eleven 5"x8" (13x20cm)	Color Twelve 8"x13" (20x32cm)
		
Color Thirteen 3"x5" (8x13cm)	Color Fourteen 22"x44" (55x115cm)	
		

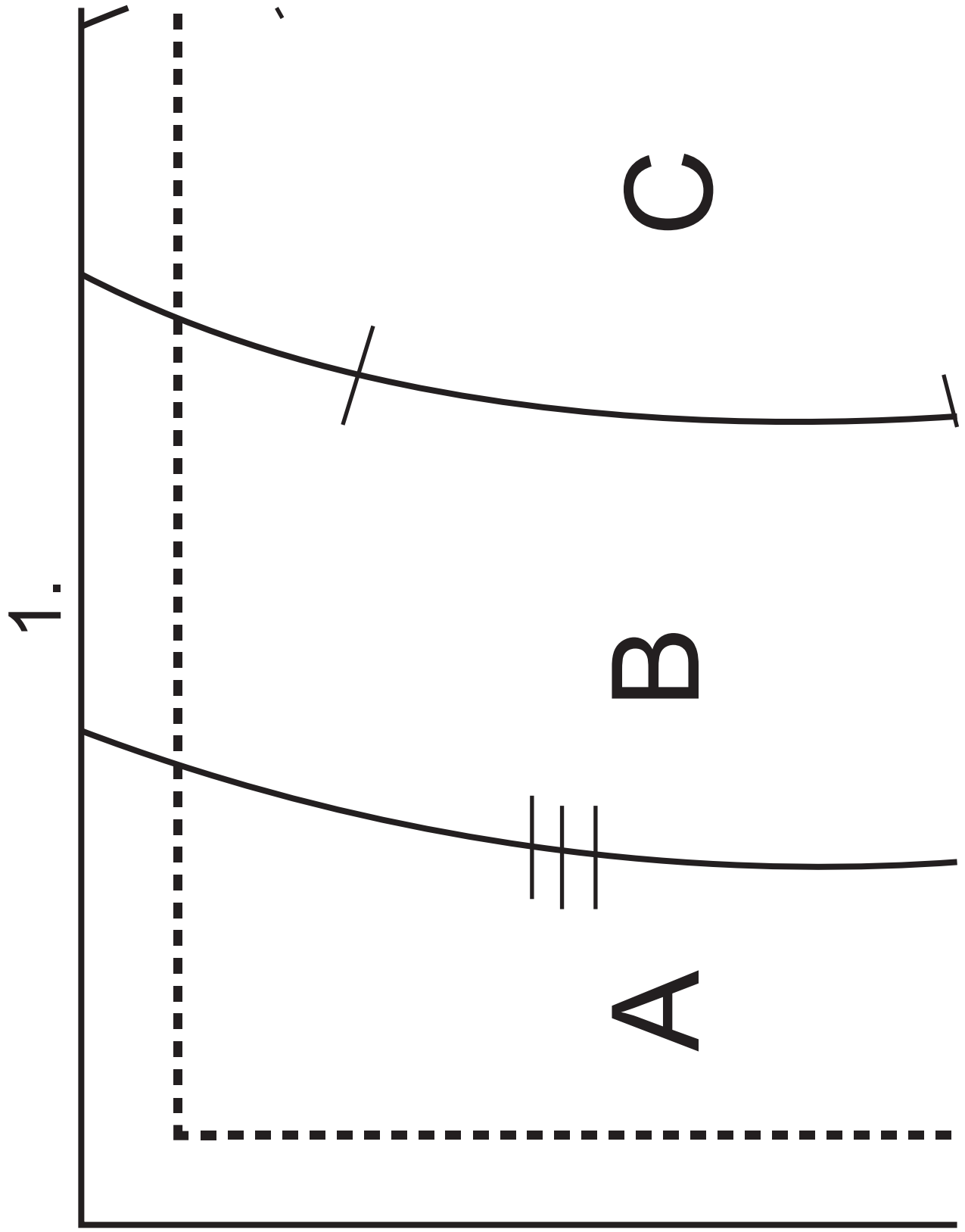

2.

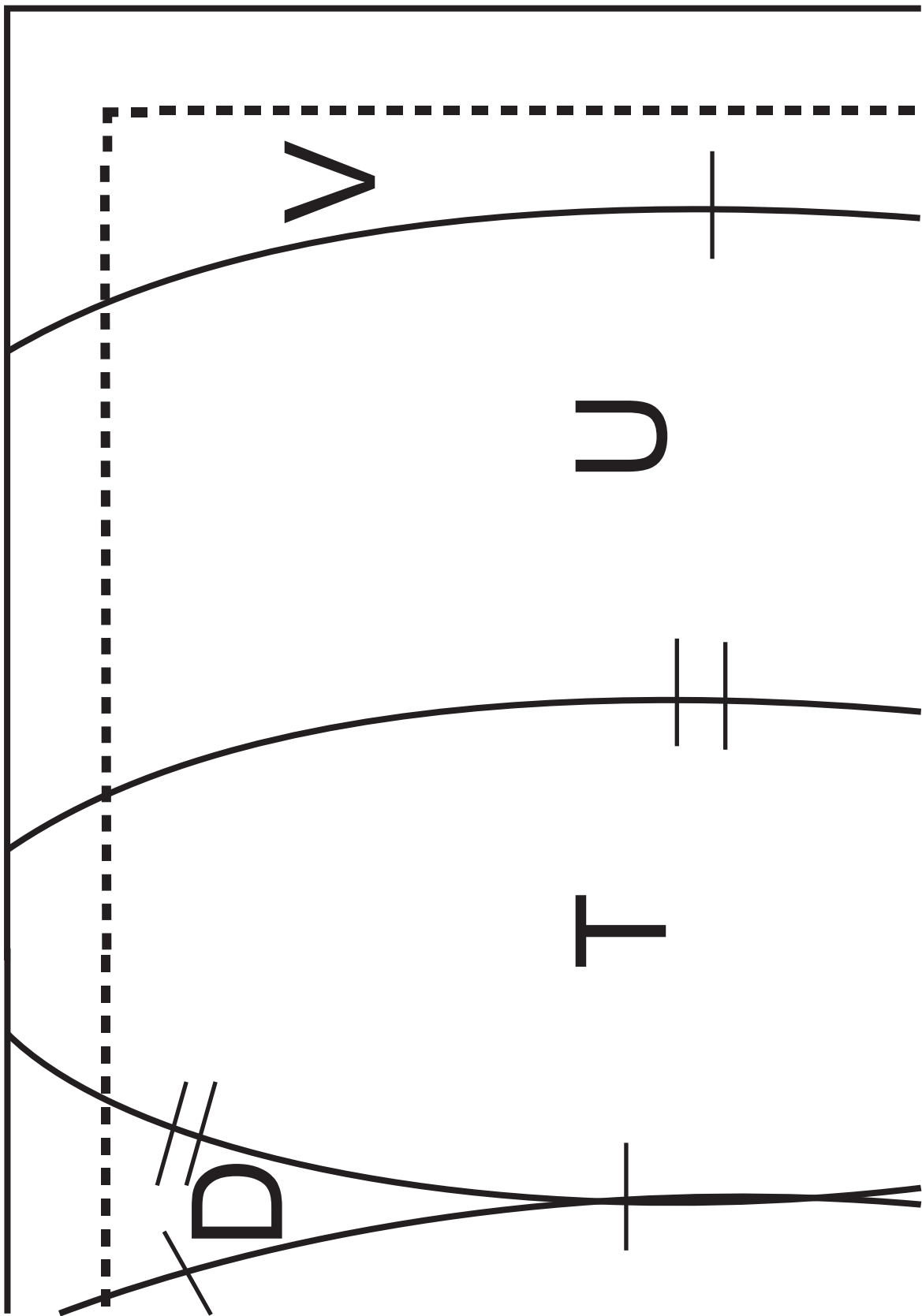

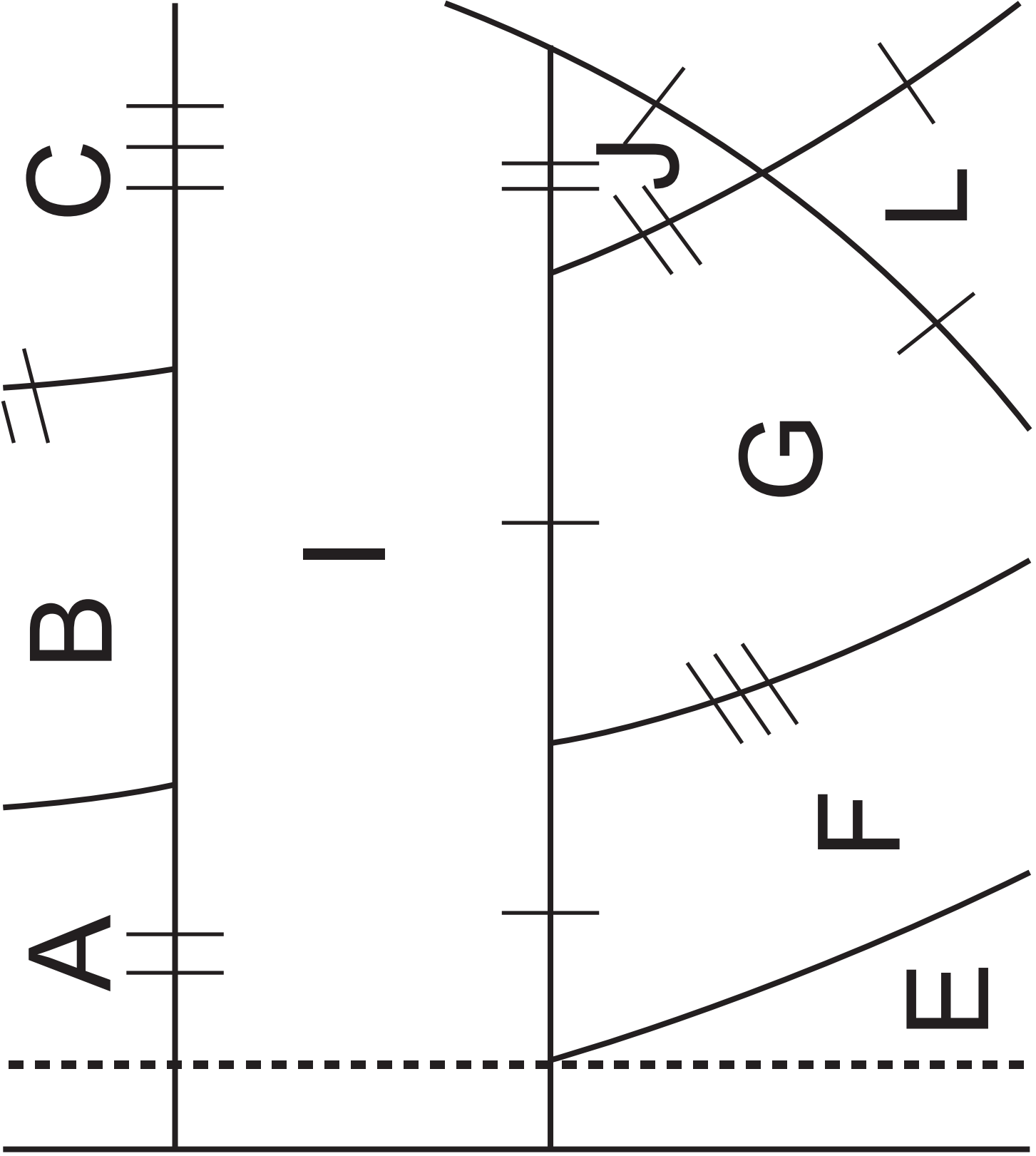

3.

4.

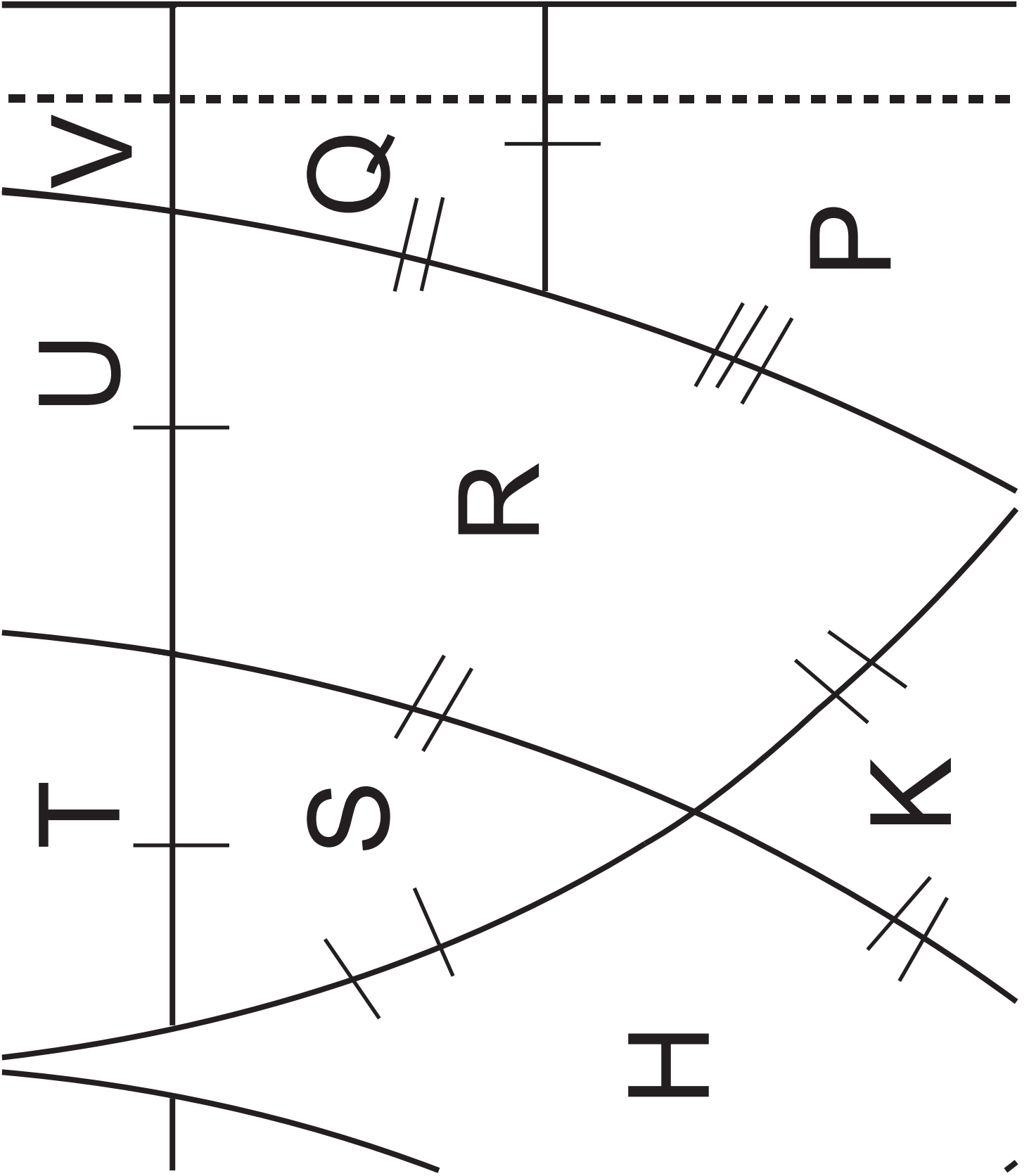

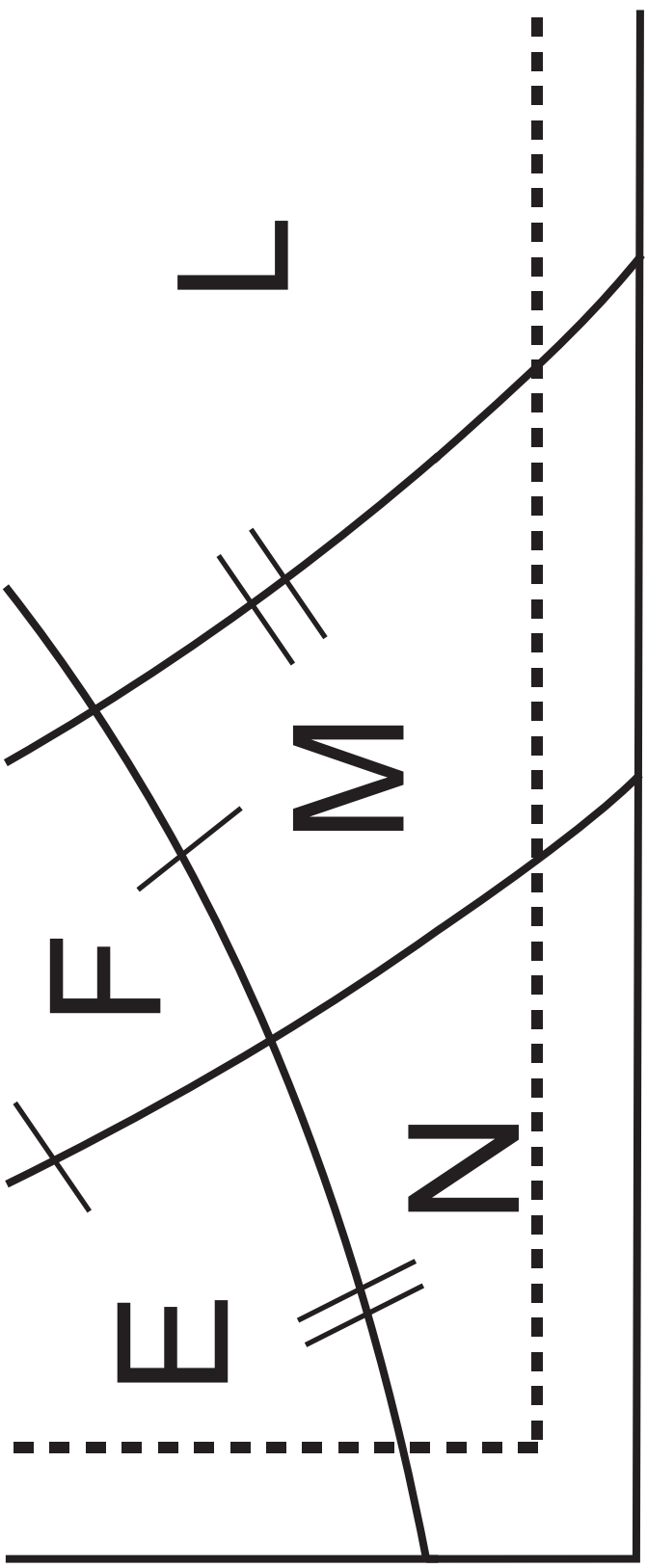

5.

